

MACHINING OF BOARD EDGES

EDGE PROFILE OPTIONS INCLUDE:

H-TG1

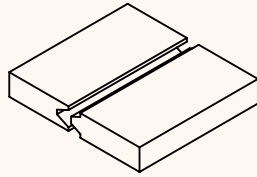
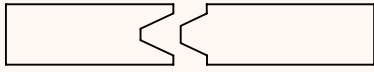

HALF LAP H-PS

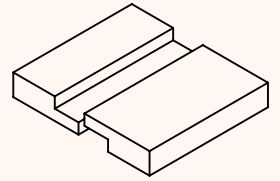
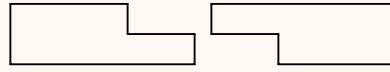

H-TG2

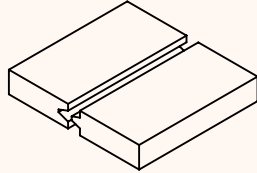
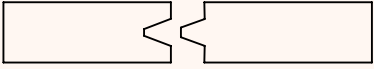

H-G

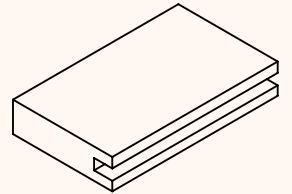

H-TG3

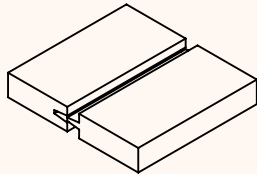
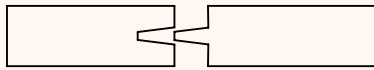

H-M4

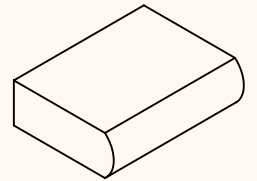
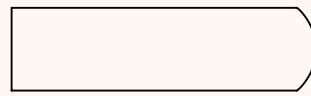

H-TG4

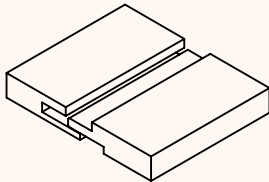
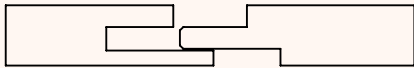

H-M11

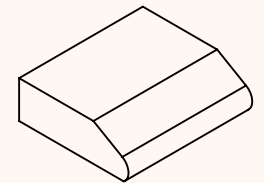
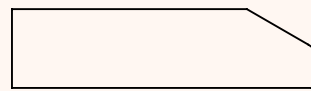

PLYWOOD PROCESSING OPTIONS



EXAMPLES OF DRILLS WITH CNC-MACHINES

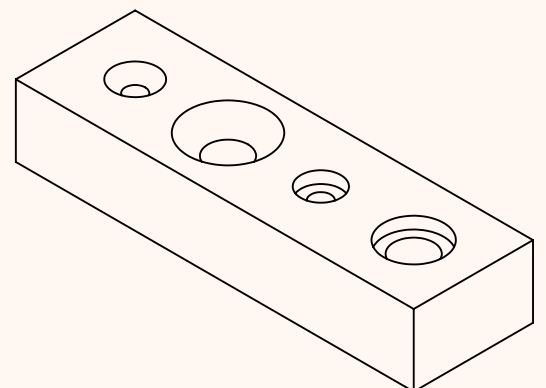
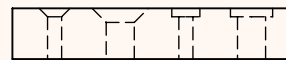
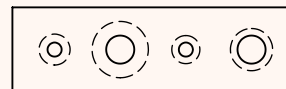

DEMANDING COMPONENTS

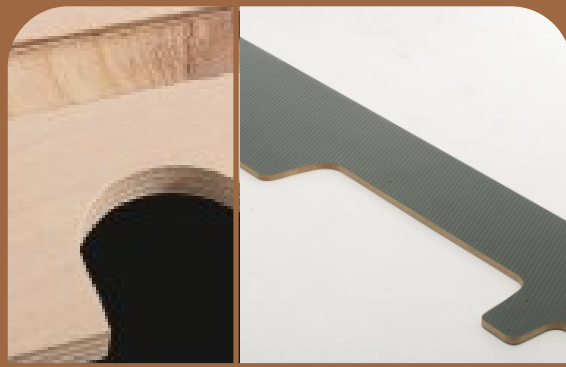
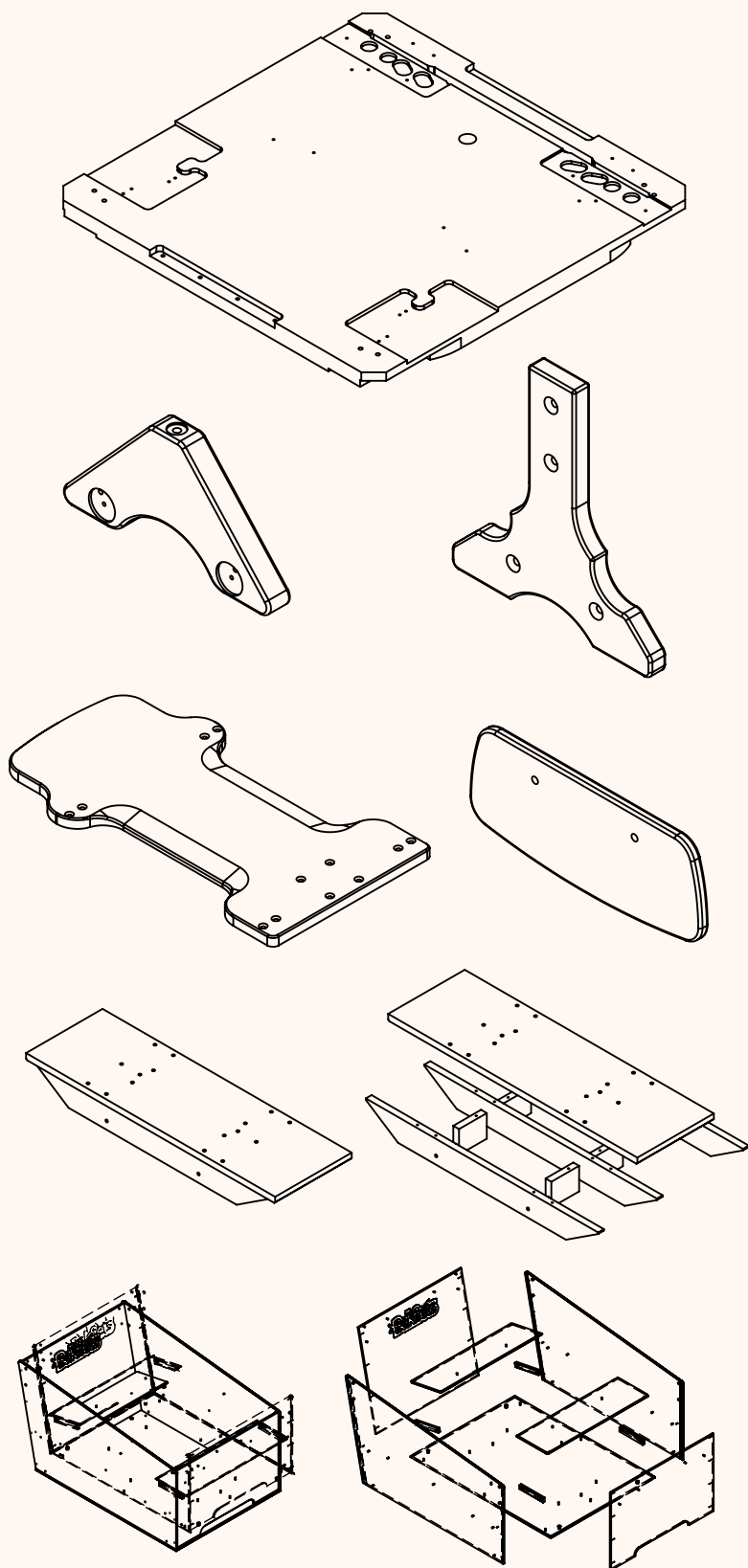

Plywood is manufactured by *als Latvijas Finieris* whose Quality Management System is certified to the requirements of ISO 9001 by Bureau Veritas Certification

ISO 9001
BUREAU VERITAS
Certification



LATVIJAS FINIERIS

AKCIJU SABIEDRĪBA



Bauskas 59, Rīga, LV-1004, Latvia
Phone +371 67620857
Fax +371 67820112
E-mail: info@finieris.lv
<http://www.finieris.com>